

User manual

Digital Devices Max S8 4/8 Tuner Card



Contents

| | | |
|-----------|--|-----------|
| 1 | Safety Considerations..... | 3 |
| 2 | Operating Safety | 3 |
| 3 | Installation - Precautions..... | 4 |
| 4 | Electromagnetic Compatibility | 4 |
| 5 | Cleaning | 4 |
| 6 | Data Backup..... | 4 |
| 7 | Installation of Max S8 - DVB Card..... | 5 |
| 7.1 | Illustration - Max S8 with connectors | 5 |
| 8 | Driver Installation | 6 |
| 9 | Wiring diagram | 7 |
| 9.1 | Settings in Linux Driver | 7 |
| 9.2 | Settings under Windows® in DD Control Center | 8 |
| 9.3 | Settings for the operating mode | 9 |
| 9.3.1 | Quad LNB or 4 Multiswitch Outputs..... | 9 |
| 9.3.2 | Quattro LNB or Multiswitch cascade output (VL, VH, HL, HH) | 9 |
| 9.3.3 | Single cable reception (EN 50494/50607) | 10 |
| 9.3.4 | Tuner Typ DVB-S/S2 (Max S8 Serie)..... | 11 |
| 10 | Use of DVB-S and DVB-S2 in Windows® Media Center..... | 11 |
| 11 | Use Common Interface Moduls with Max S8 | 12 |
| 12 | Digital Devices..... | 13 |
| 12.1 | Produktportfolio..... | 13 |
| 12.2 | Serviceinformationen | 13 |
| 1. | Notizen | 14 |

1 Safety Considerations

- Please read the following safety instructions carefully to ensure reliable operation and long life of your TV card.
- Protect your TV card and the PC from moisture, dust, heat and direct sunlight at all times to avoid the risk of damage and malfunction.
- Keep this manual within reach of your PC for easy access at all times.

2 Operating Safety

- Follow this advice and the instructions carefully.
- The TV card should be installed by a properly qualified technician or a person with relevant knowledge and expertise.
- Before installing the TV card, disconnect the PC from the mains power supply. Failure to do so could lead to serious injury and/or damage.
- This TV card is intended only for use in a PC and to be powered via PCI Express bus.
- Do not try to work through slots or other openings in your PC with tools. Doing so could cause an electrical short circuit and/or fire.

Electrostatic discharge (ESD) can damage the internal components of a PC. Any changes to the system, including enhancements and upgrades, should be carried out at an ESD-protected workplace.

If such a workplace is not available, use an anti-static wrist strap or maintain constant physical contact with a highly conductive metal body.

No liability will be accepted for damage caused by ESD as a result of improper handling.

Please contact your supplier if you have any of the following technical problems with your TV card.

- Your TV card has come into contact with liquid.
- The TV card is not working properly.

Never let children play unsupervised near electrical equipment.

They are too young to recognize the hazards.

3 Installation - Precautions

- Following receipt of your TV card, allow it to warm to room temperature before starting the installation procedure to avoid the risk of an electrical short circuit. High temperatures and/or variations in humidity can cause condensation, which can lead to an electrical short.
- Site your PC on a flat, stable, vibration-free surface to avoid the risk of accident and injury.
- Damage from electrical shock can be avoided only if ALL cables to external devices, telephone networks and mains power are disconnected.
- Most damage is caused by lightning strikes to telephone networks and spikes in mains voltage.

4 Electromagnetic Compatibility

- The guidelines for electromagnetic compatibility (EMC) must be observed at all times when connecting the TV card.
- A minimum distance of 40 inches should be maintained from TVs, mobile phones, speaker cabinets, etc. to avoid high frequency and magnetic interference.

5 Cleaning

- The TV card does not require cleaning under normal operation.
- In the unlikely event that cleaning is required ensure all power connectors and mains cables are properly disconnected.
- The TV card has no serviceable parts. Protect it from contamination (see Safety Considerations above) and do not use solvent, caustic or gaseous cleaning agents.
- If necessary, the external connectors of the TV card can be cleaned with a soft, dry anti-static cloth.

6 Data Backup

- Always make a backup copy of your data on a suitable external storage medium (CD, floppy, Zip etc.) before and after updating.
- Claims for damages in respect of lost data and consequential losses arising from lost data will not be accepted.

7 Installation of Max S8 - DVB Card

- Read the safety instructions for your PC and those on previous pages.
- Turn off the PC and all peripheral devices.
- Unplug the power cable and remove all other external cables.
- Unscrew and carefully remove the PC cover to gain access to the inside.
- Unscrew the blank slot bracket from a free PCIe slot and remove it.
- 1 slot brackets (full profile) are enclosed in the package.
- Carefully screw the slot bracket to the TV card.
- Holding the TV card by its edges, position it vertically over a free PCIe slot (x1 up to x16) and insert it into the slot. Avoid touching the golden finger of the TV card and do not damage any internal components.
- Push the TV card into the slot from above, so that the TV card snaps into position in the slot.
- Screw the slot bracket of the TV card to the PC chassis.
- Replace the PC cover and reconnect all cables.
- The installation of your new TV card with its connections is now complete.
- Finally, connect the power cable to the PC and switch on the PC.
- Do not try to start the PC unless the PC cover is tightly refitted and secure

7.1 Illustration - Max S8 with connectors

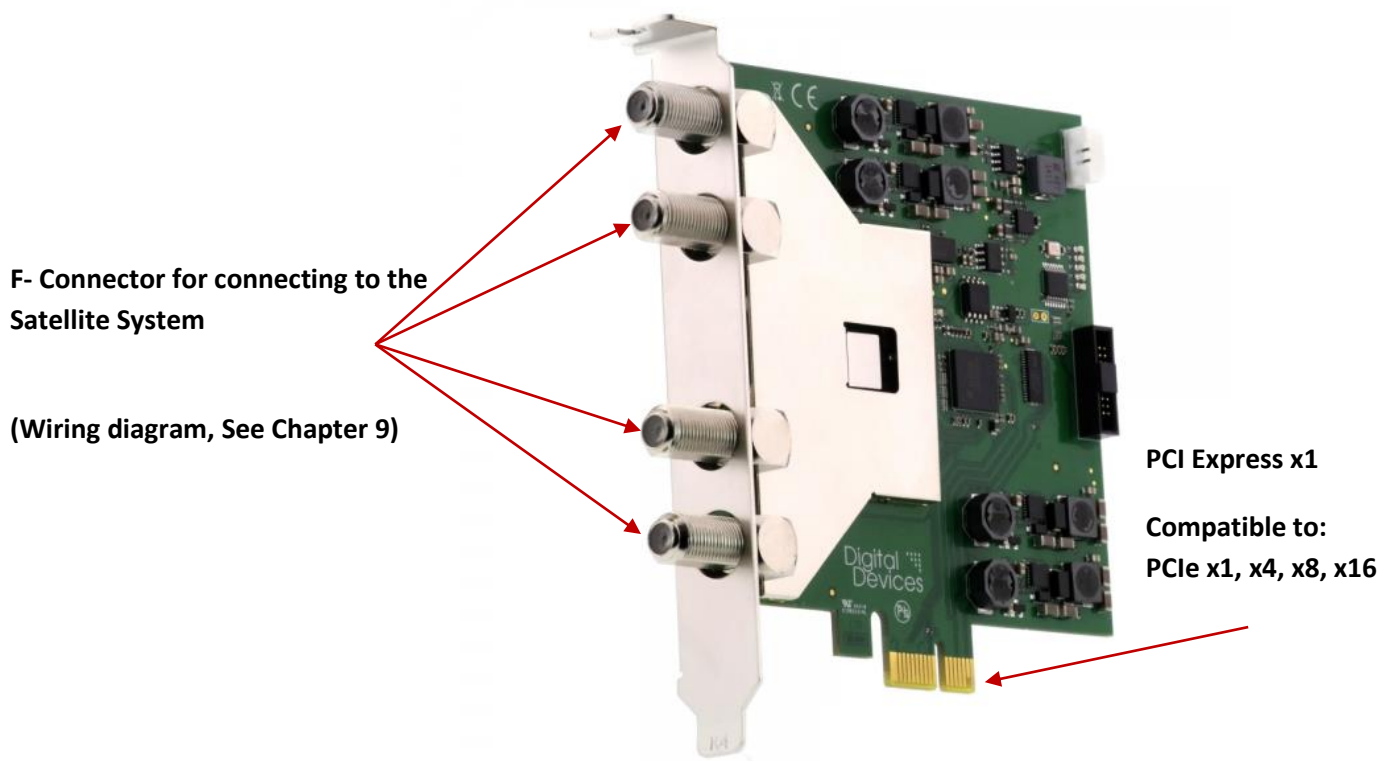

8 Driver Installation

- The TV card has now been installed in your PC in accordance with the previous sections and you have restarted the computer.
- Drivers are available for the following operating systems:-
 - Windows® XP (32/64 bit)
 - Windows® Vista (32/64 bit)
 - Windows® 7 (32/64 bit)
 - Windows® 8 und 8.1 Versionen (32 und 64 Bit)
 - Linux
- In Windows® XP, you must log on with an administrator account.
- Open your web browser and go to www.digital-devices.de
- On the home page click on „**Service/Help -> Driver and Documentation**“ and when the page has opened download the appropriate drivers and save to a convenient location. (executable file: „DigitalDevices DVB Driver X.msi“)
- For Windows® run the setup program by double clicking the file you just downloaded „DigitalDevices DVB Driver X.msi“.
- Follow the on-screen instructions.
- When the installation is complete, restart the computer.
- The Unicable® feature is integrated in the driver, and can be configured via the „**DD Control Center**“ in the control panel.

If your operating system is configured by default to accept only Microsoft® approved (signed) programs and drivers, a warning message may appear:

“Windows® cannot verify the publisher of this driver software ...”. This is not an indication of a fault with the driver, but to the absence of Microsoft® WHQL certification and can therefore be ignored by clicking the „Next“ button or the option to, “Install this driver software anyway...”

Instructions for install under a Linux OS and drivers, you can find here:

<http://support.digital-devices.de/knowledgebase.php?article=124>

<http://download.digital-devices.de/download/linux/>

When new drivers or programs are installed, existing data is overwritten or changed. You should accordingly create a backup copy before installation on your hard drive. Claims for damages in respect of lost data and consequential losses arising from lost data will not be accepted.

Please ensure you follow the safety precautions for your PC (consult the PC manual).

9 Wiring diagram

Your Digital Devices Max S8 can be connected to your satellite reception system according to the following scheme. Depending on the variant you use, you must set the settings in the driver under Linux or via the DD Control Center under Microsoft® operating systems.

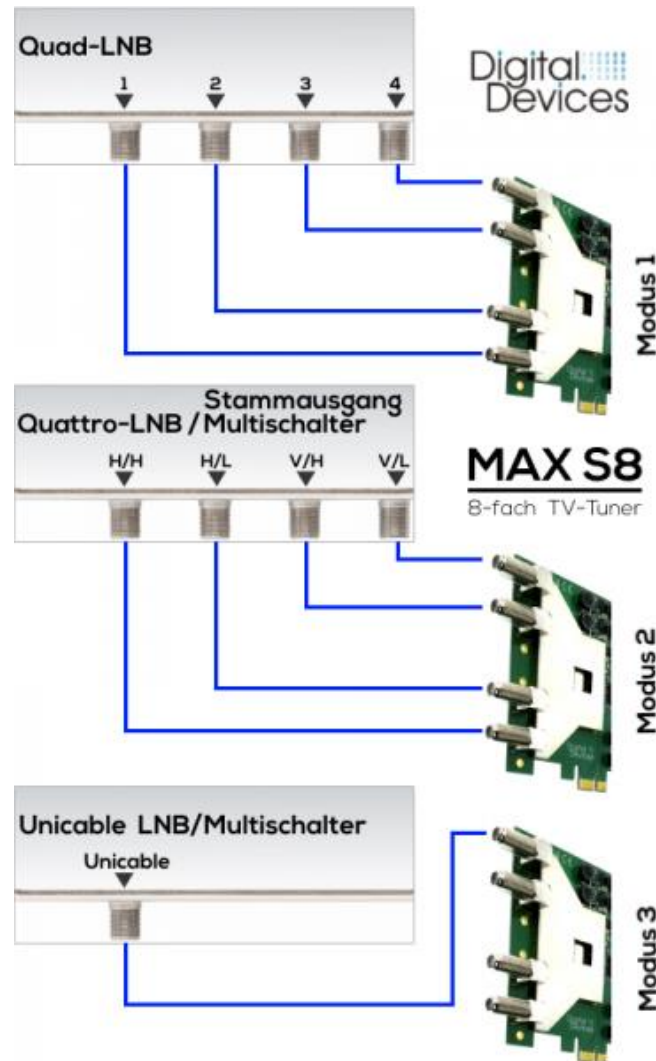

9.1 Settings in Linux Driver

Set following `ddbridge` parameter for `fmode`:

- `fmode = 0` Demod 0 & 4 at Input 1
Demod 1 & 5 at Input 2, etc.
The input for each front end can be changed using: `ioctl DTV_INPUT`
- `fmode = 1` All the cables are connected via a quad LNB
- `fmode = 2` All cables are connected via a Quattro LNB or Multiswitch cascade output: Input 1=VL, 2=VH, 3=HL, 4=HH
- `fmode = 3` All Demods are connected to Input 1 and send JESS or SCR (Single Cable Routing - one cable solution) commands from the application

9.2 Settings under Windows® in DD Control Center

Is your Max S8 in Microsoft® Windows® System Installed, here are the configuration options (selecting the operating mode) in DD Control Center. Start on your Windows® PC the Control Panel.

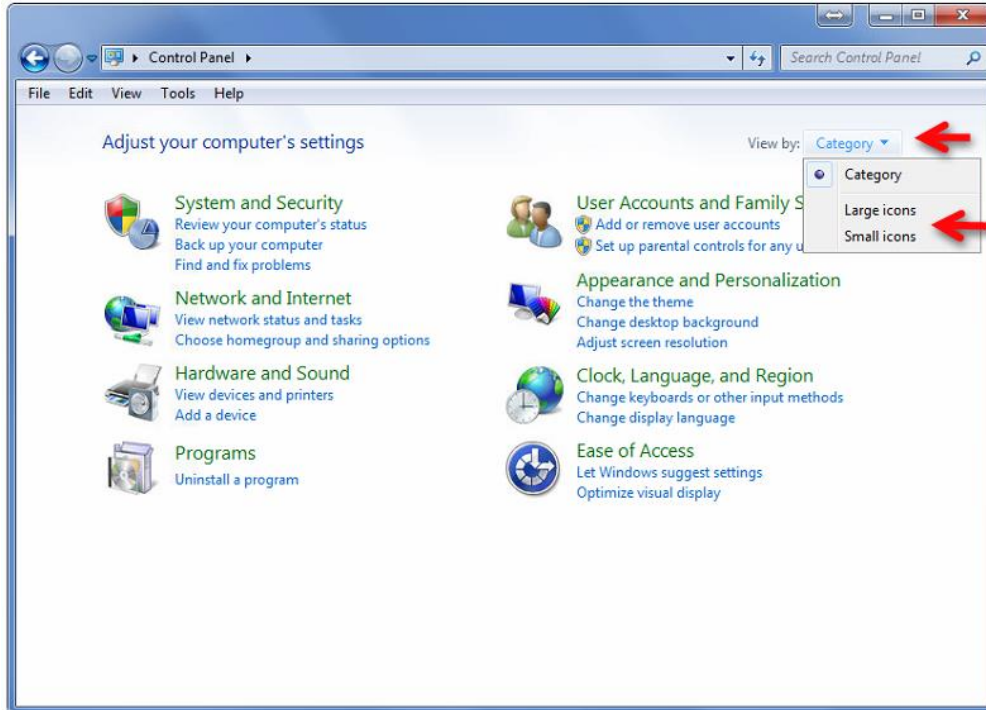

Select under „**Category**“ the option „**Large icons**“ or „**Small icons**“.

The overview of the Control Panel is now changing and it shows all available functions.

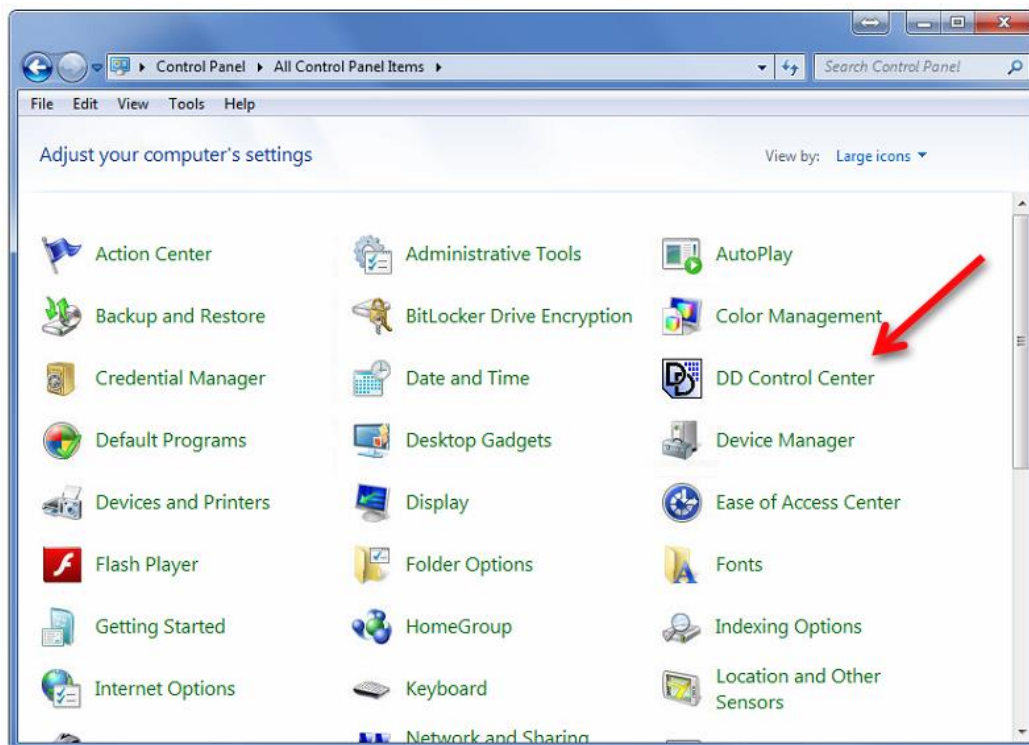

Under the entry DD Control Center, you can start this by clicking on the entry.

» *Note: The program group "Digital Devices" no longer exists. The driver installation creates a link of the Control Center exclusively in the Control Panel. Was during the installation not selected the default directory, a start of the Control Center is only possible from the installation folder.*

» *Tipp: You can create a shortcut of the „DD Control Centers“ to your Desktop, if you make a right-click on the entry and choose „Create Shortcut“. In next you find a Shortcut on your Windows® Desktop*

9.3 Settings for the operating mode

Select the menu item of the Max S8 card from the left half of the window:

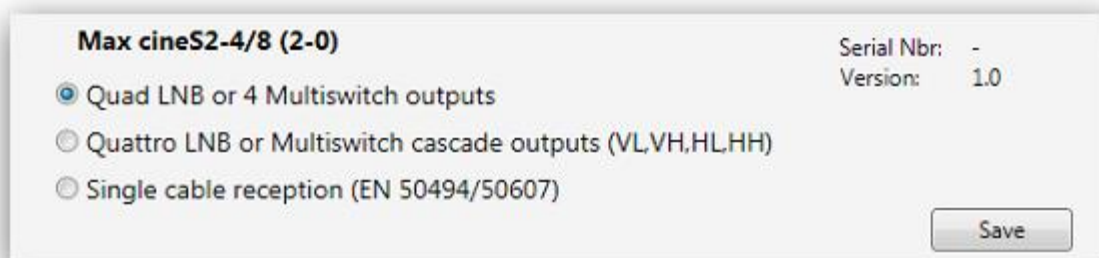

9.3.1 Quad LNB or 4 Multiswitch Outputs

Use this option if you want to connect your Max S8 to a normal multiswitch or LNB with integrated multi-switch (QUAD LNB or OCTO LNB). For both cases, four SAT lines are required to provide a full-featured and full reception (all four levels SAT).

9.3.2 Quattro LNB or Multiswitch cascade output (VL, VH, HL, HH)

Use this option if you want to connect your Max S8 to a multi-switch, which can be cascaded. Such multi-switch have in addition to the inputs for a Quattro LNB, four outputs which are also known as "cascade outputs". These outputs give only from a Quattro LNB received signals unaltered out again. Alternatively, the four outputs can be directly used by a Quattro LNB without multiswitch.

»*Note: A "Quad LNB" are called LNBs, which provide an integrated multi-switch with four outputs for a direct connection to receivers. No external multiswitch is needed. Octo LNBs offer instead of 4 outputs a total of 8 outputs with the same engineering.*

Quattro LNBs other hand, have no integrated multiswitch. These LNBs offer only the SAT levels (V/L V/H H/L H/H), which must connected to an external multiswitch.

9.3.3 Single cable reception (EN 50494/50607)

Enable this option if you want to use a Max S8 for the reception at a single cable system. The settings for single-cable reception systems according to EN50494 and EN50607 are configured for the Max S8 exclusively in this menu. (The menu item "Tasks -> Single cable reception" is not to be used for the Max S8.)

| Tuner | Slot |
|-----------------------|------|
| 2-0: DVB-S/S2 Tuner 1 | 1 |
| 2-0: DVB-S/S2 Tuner 2 | 2 |
| 2-0: DVB-S/S2 Tuner 3 | 3 |
| 2-0: DVB-S/S2 Tuner 4 | 4 |
| 2-0: DVB-S/S2 Tuner 5 | 5 |
| 2-0: DVB-S/S2 Tuner 6 | 6 |
| 2-0: DVB-S/S2 Tuner 7 | 7 |
| 2-0: DVB-S/S2 Tuner 8 | 8 |

Select under „**Manufacturer**“ the manufacturer of your LNB or Multiswitch. Subsequent

In next select under "**Device (Switch/LNB)**" your model. If your manufacturer or model is not in the list, you can select a different model, if it uses the same frequencies and is not pin Protected, or select the option "**Other Manufacturers**" from the drop down box.

All tuners that can be configured for single-cable reception will be listed, under "**Tuner**". Over "**Slot**" you can assign the appropriate frequencies for each tuner.

»Note: Single cable reception systems are known by names like: Unicable® - UniCable II® Jess® - SCR (Single Cable Routing) - single-cable solution. If your single-cable multiswitch / LNB have a "pin protected" option, you must enter the PIN for the appropriate frequency. This option is available only if your multiswitch or LNB has the "Pin Protected" option. Usually the PIN defined by the LNB or Multiswitch and can be found in the user guide.

9.3.4 Tuner Typ DVB-S/S2 (Max S8 Serie)

The following options are available for this type of tuner:

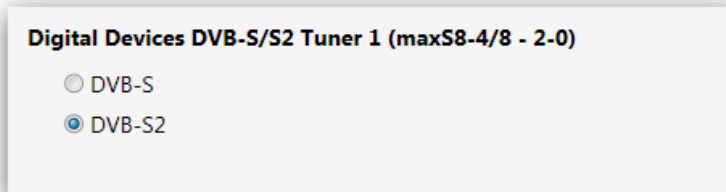

Some programs (such as Windows® Media Center) does not automatically detect whether it is the received transponder type is DVB-S or DVB-S2. In this rare case, the tuner can be switched to the appropriate operating mode "**DVB-S**" or "**DVB-S2**".

10 Use of DVB-S and DVB-S2 in Windows® Media Center

If you want to use your Max S8 card in Windows® Media Center, you must apply for both reception formats simultaneously, the following workaround:

- Set the operating mode for all tuners of the MaxS8 to "**DVB-S**"
- In the Home menu, select "**Ignore NIT Lists in Windows® Media Center**"
- Load as normal your transponder list in Windows® Media Center, using the "**Control Center**" or the "**DD channel sorter for Windows® Media Center**".
- Save the settings and close the DD Control Center (reboot may be required)
- If you have loaded a transponder list by using the DD Control Center or the DD channel sorter for Windows® Media Center, disable in Windows® Media Center under Tasks -> Settings -> General -> Automatic Downloads -> the first checkbox (CD Cover, media information DVDs and movies ...)
- Run the setup Wizard in WMC for setup the TV signal. If you have loaded a transponder list using the DD Control Center or the DD channel sorter for Windows® Media Center, select in the wizard at the step, "Update TV setup data ->No" because otherwise the loaded data will be overwritten with the Microsoft® transponder lists again.
- Run after Setup under „Task -> Settings -> TV -> TV signal -> Satellite transponder scanning – a “Complete tranponder scan“.
- Afterwards start the DD Control Center again.
- Set the operating mode for all tuners of the MaxS8 to „**DVB-S2**“
- Save the settings and close the DD Control Center (reboot may be required)

The setup for Windows® Media Center is now complete. Should there problems occurs, run once a complete transponder scan in Windows® Media Center, with the setting for all tuners on "**DVB-S2**".

»Note: During the search, other channels may be found. These channels will be appended by Windows® Media Center at the end of your channel list. It is also possible the encrypted channels are disabled in Windows® Media Center, they must subsequently on Tasks -> Settings -> TV -> TV program -> Edit Channels - are re-enabled with the appropriate check box in front of the channel name.

11 Use Common Interface Moduls with Max S8

You can use with your Digital Devices Max S8 DVB card a CI module from our house. The following CIs can be used:

- Digital Devices Octopus Single CI (1x CI Slot)
- Digital Devices Octopus Twin CI (2x CI Slot)

For using these CIs an additional PCIe slot is required.

»Note: The Digital Devices Max S8 has a 20 pin connector. This connector is not suitable for the connection of expansion modules, such as the Digital Devices Flex CI or Digital Devices DuoFlex tuner expansion modules. The MTD feature for the CI modules are only available for Windows® and is limited even at the Max S8 for up to 4 tuners for one CI slot.

12 Digital Devices

Digital Devices was founded in 2009 and is now a "GmbH" under German law. Digital Devices GmbH has been profitable since the first fiscal year. The company consists of a team of owners (Engineers) and covers a broad product range of products primarily in the DVB area and other related products.

Competence and development skills:

- Hardware design, 3D Designs
- Software development (Windows®- and Linux Driver)
- DVB-Technology
- programmable Logic (FPGA)
- HF-Technic

The focus of the designs is the seamless functionality between all Digital Devices products.

12.1 Produktportfolio

Digital Devices launched its first DVB products in 2009 (satellite and cable/terrestrial) and added a Common Interface shortly after that. The portfolio has been expanded to a range of Tuner modules, bridges and DVB related products. Digital Devices has become a leading provider for embedded tuners in the PC market.

Digital Devices Product portfolio:

- Standard DVB cards, Common Interfaces and Bridge modules (Windows® and Linux)
- Headend devices
- PC mainboards
- Surveillance cameras and –systems

The DuoFlex series complements the Cine series by Twin Tuner extensions via ribbon cable (no additional PCIe slot required), especially in compact environments. The DuoFlex series is also available as an extension for the Octopus series.

The Octopus series offers numerous opportunities for special TV tuner environments for hobby but also especially for business solutions. Combinations with CI extensions and external solutions are an example of the flexible modular combining ability in our DVB-portfolio for the PC market.

Explore the world of Digital Devices under www.digitaldevices.de

12.2 Serviceinformationen

In service cases, please contact our support at support.digital-devices.de. You can also reach us by phone and email.

Digital Devices Distribution GmbH
An der Geis 67
D 47228 Duisburg

info@digital-devices.de
www.digital-devices.de

Support by mail: support@digital-devices.de
Support by phone: +49 (0)2065-698 99 44

